

DENVER E-RIBBON FIRE™ 700mm

www.decoflame.com

The DecoFlame Denver e-Ribbon Fire™ is part of the made to measure range of DecoFlame bioethanol fires. Its simple layout makes it versatile and adaptable for a large variety of fireplace applications.

Offering a maximum of creative freedom and in addition to the classic linear form, the Denver e-Ribbon Fire™ can be sculptured in various shapes e.g. along an in- or outside corner, in a U-bend or like an elegantly meandering wavy curve.

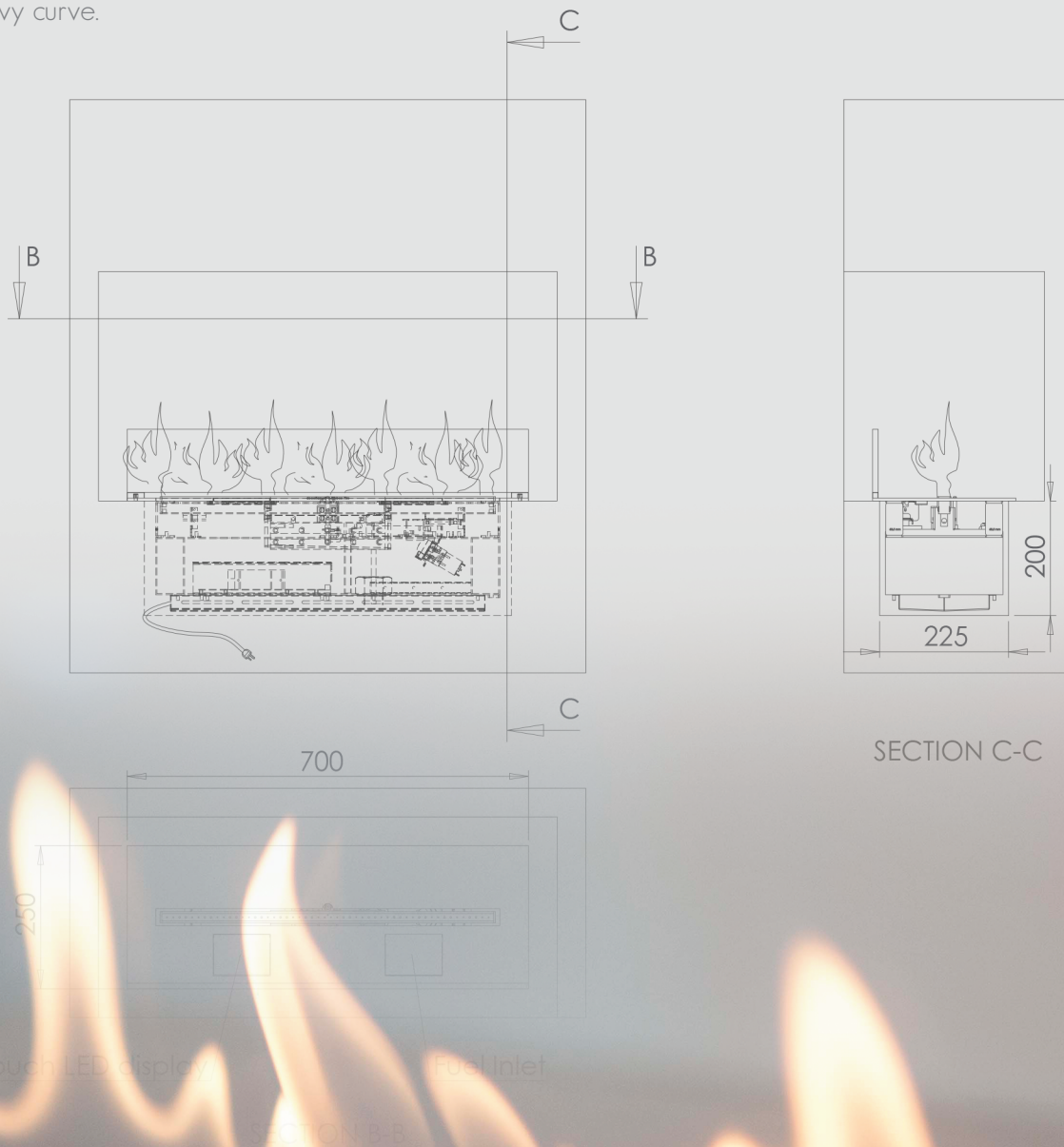

Dimensions are in
MATERIAL:
WEIGHT: kg
REVISION:

Copyright of DecoFlame
where properly the
name of the product
is used in any
medium or form
without the written
consent of DecoFlame

decoflame® e-Ribbon Fire

DENVER E-RIBBON FIRE™ 700mm

www.decoflame.com

Download 2D Cad Denver 700

FEATURES

- e-Ribbon™ technology
- Touch Display
- Bluetooth / App control
- Remote Control
- 1-5 + Eco flame levels
- Smart home connection
- Safety sensors
- No chimney required
- 5mm Steel baseplate
- Black/White or BSS finish
- Sleep Timer
- Safety chamber
- Glass screen

TECHNICAL INFORMATION 700mm

Flame tray size: 600mm
Capacity: 5,7 L
Fuel consumption: 0,25 L - 0,66L
Burning time: 9h - 20h
Heat output: 1,4 kW - 3,7 kW
Net weight: 30kg
Minimum room size: 77m³
Power supply: 220V - 240V - 50 Hz
Finish: Powder-coated aluminum or brushed stainless steel and optional hardened, optic-white glass

OPTIONAL

- Made to measure
- Extra glass screen
- Integration in made to measure fire-places
- RAL colors
- TV temp. sensor



STANDARD FINISHES



OPTIONAL

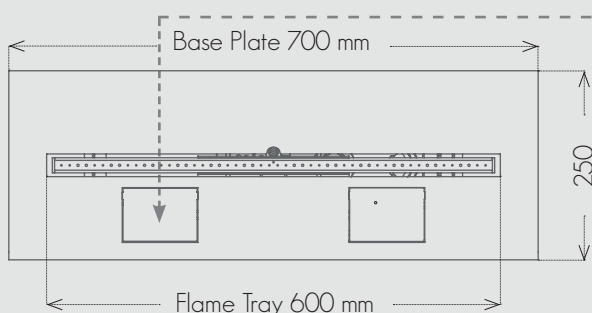
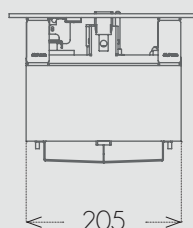
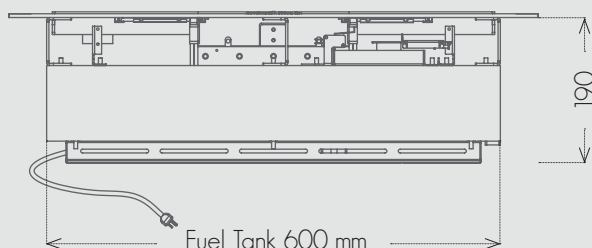
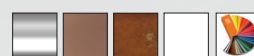

Touch Screen

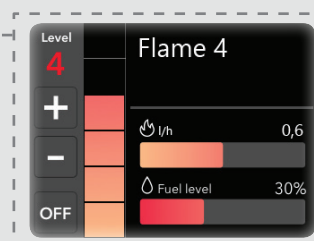

DENVER E-RIBBON FIRE™ 700mm

www.decoflame.com

Cut-out dimensions

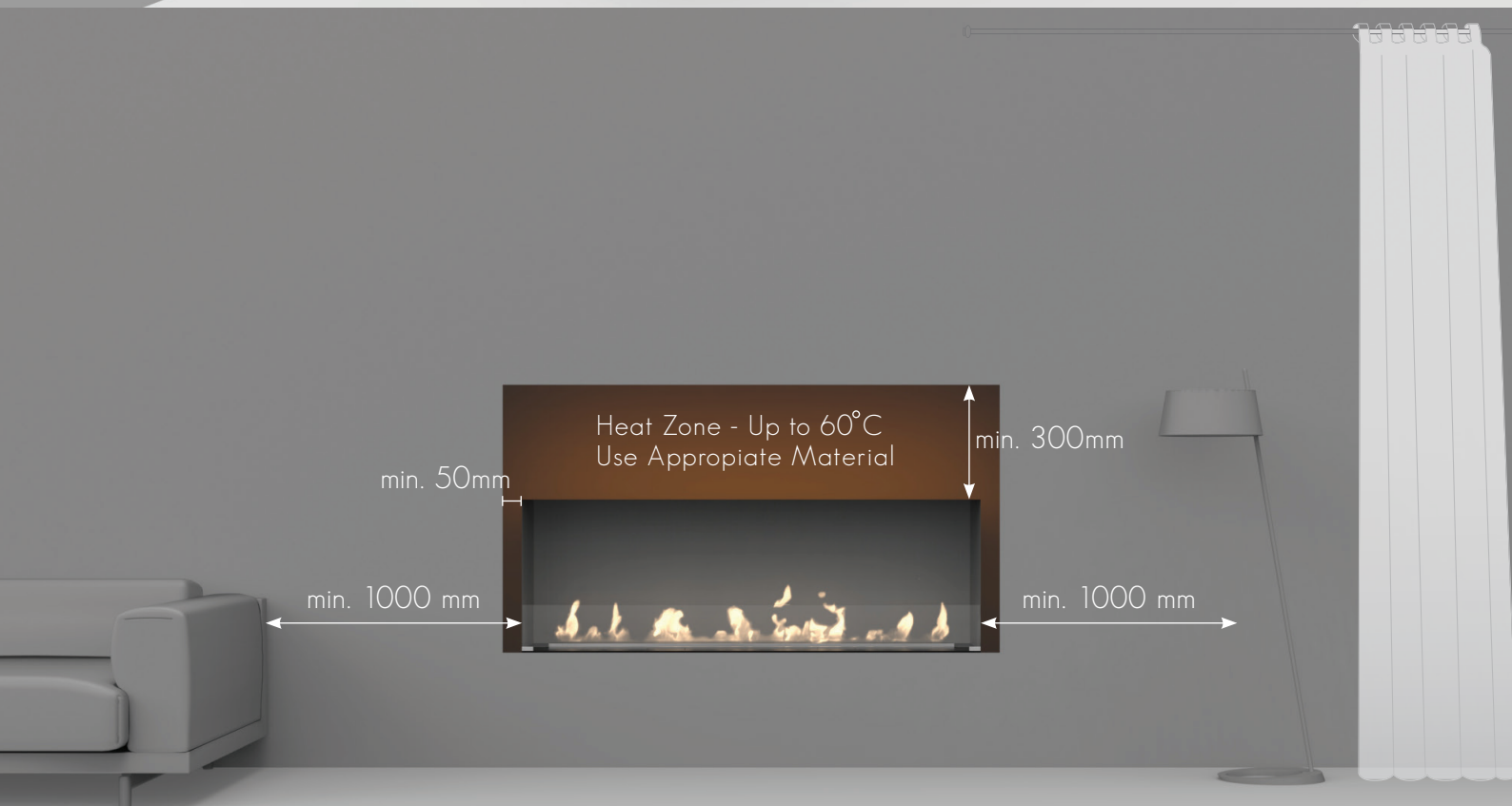
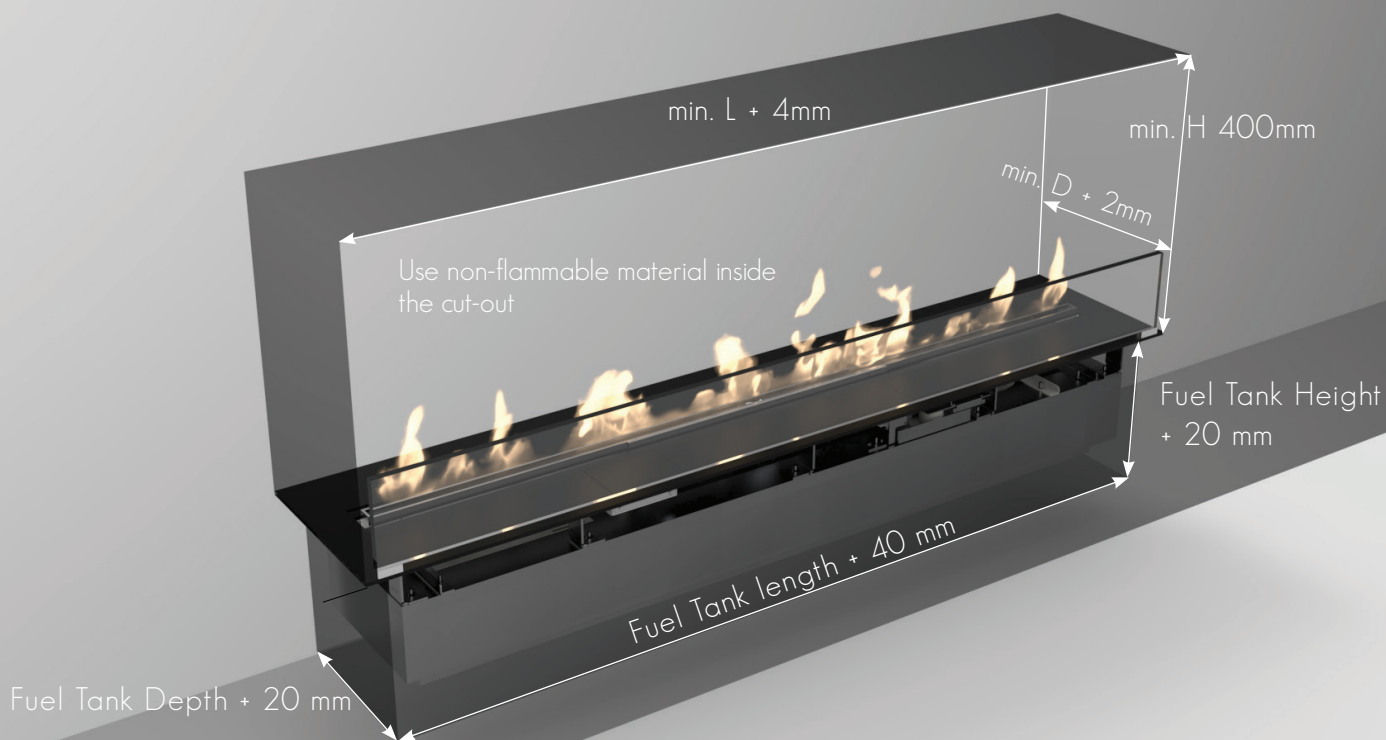

DENVER E-RIBBON FIRE™ 700mm

www.decoflame.com

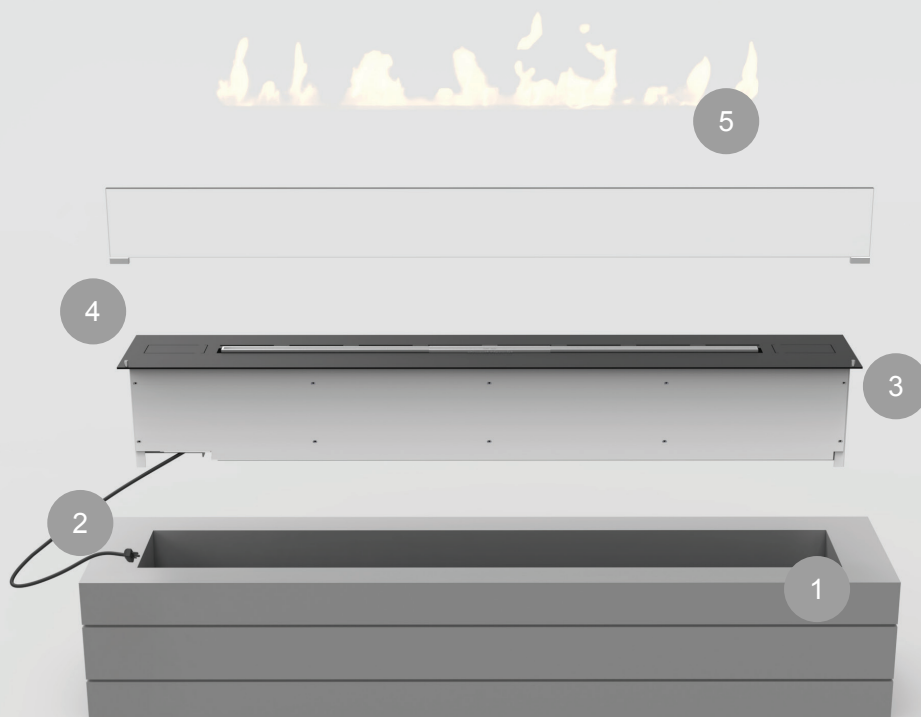

Step 1: Make sure that the dimensions of the cut-out correspond to the measurements indicated in the technical drawing received with your fireplace.

Step 2: Connect the fireplace to a source of electricity.

Step 3: Recess the fireplace into the wall cut-out according to the indications in the User's manual.

Step 4: If the case, place the glass screen on the top plate by fitting the pin holders into the holes.

Step 5: Turn on the display. Fill in the right amount of bioethanol by verifying the level on the display.

Step 6: Start the fireplace by pressing the ON icon on the display.

Enjoy your fire.

DecoFlame Bluetooth Application Installation



App Store



Google play

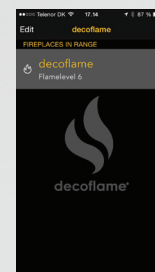
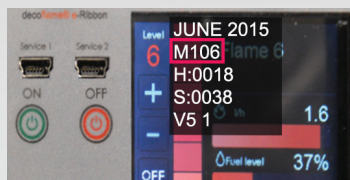

1. Download and install the DecoFlame App by scanning the QR code above corresponding to your smart device's operating system.

2. In order to pair your fireplace with your smart device, start the fireplace by pressing 'ON' button and insert the code highlighted above.

Note: The code will appear only for a few seconds. Make sure that you write it down or take a picture of it.

3. Once your device is paired, the fireplace should be visible on the app. You are now able to change the name of the fireplace.

Note: You are able to pair more than one fireplace like described in the step nr. 2 and give them different names.

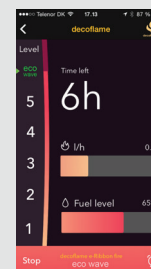
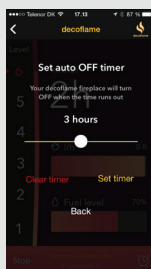
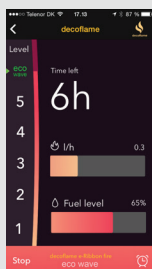

4. Once you have selected your fireplace, you can turn it on by pressing 'START'. If the fireplace has already been turned on using the display, you can now monitor the fuel level and the consumption.

5. For the 'Turn Off Timer' press the clock icon in the lower right corner. To adjust the remaining time, slide the dot to the left and right and select 'SET TIMER'. The remaining burning time can be changed by repeating the above mentioned steps. To cancel the timer select 'CLEAR TIMER'.

6. For adjusting the flame intensity, select the desired level on the left side of the screen. (1-lowest, 5-highest + eco wave) Should there not be enough fuel for the selected burning time - the fireplace will shut down automatically. Select 'STOP' to turn off the fireplace.

DENVER E-RIBBON FIRE™ 700mm

www.decoflame.com

DecoFlame strongly recommends installing one or more glass shields in order to protect the flame from draught, while keeping it vivid. Please see below the situations where the glass is optional and where it is mandatory.

Optional glass

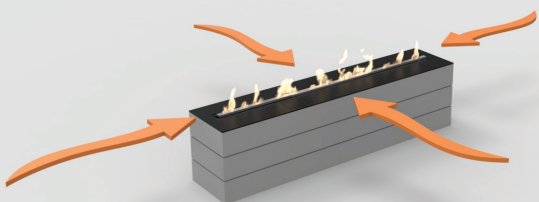

Mandatory glass

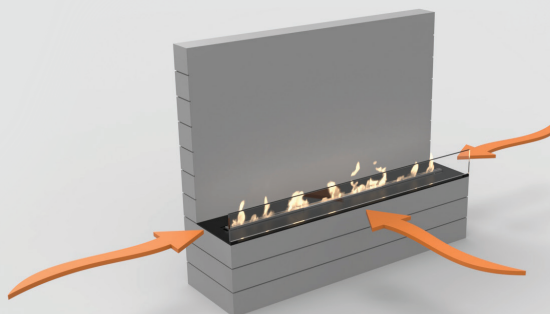

Optional glass

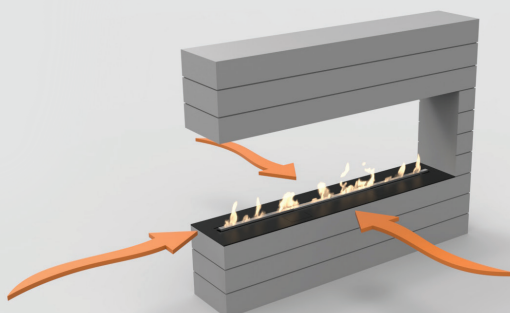

Mandatory glass

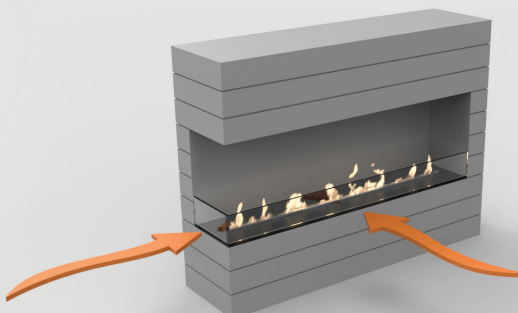

Optional glass

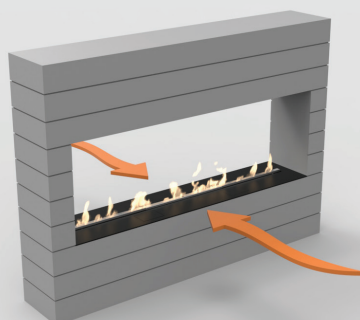

Mandatory glass

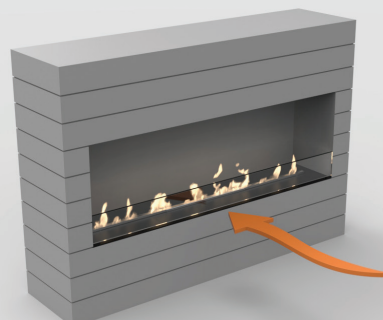

DENVER E-RIBBON FIRE™ 700mm

www.decoflame.com

It is imperative to follow the indications in the User's manual concerning the installation of decorative or electronic items above the fireplace.



DENVER E-RIBBON FIRE™ 700mm

www.decoflame.com



Take a video tour in our showroom

Take a virtual tour in our showroom

