

MONTREAL E-RIBBON™

www.decoflame.com

DecoFlame Montreal e-Ribbon Fire™ is part of the made to measure range of DecoFlame bioethanol fires. Its simple layout makes it versatile and adaptable for a large variety of fireplace applications.

Montreal™ fireplaces can be made in various shapes, ex: tunnel or open to a corner. All these variations can be seen on page 5 in this document, where you can also download 2D autocad drawing of the fireplace like the one shown below.

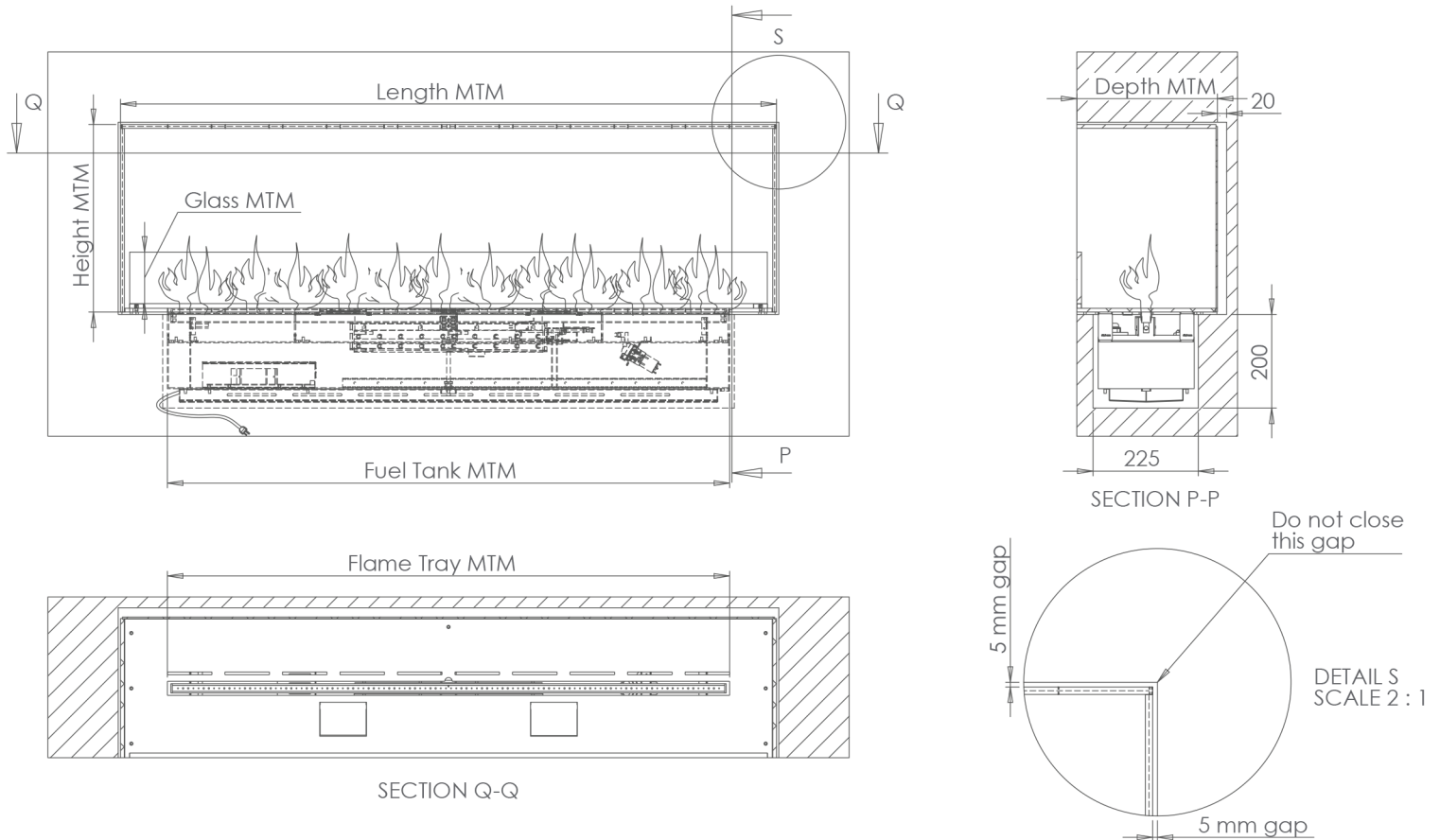

MONTREAL E-RIBBON™

www.decoflame.com

2D Cad Montreal open to front

2D Cad open to front and right side

2D Cad open to front and back

2D Cad open to front and both sides

2D Cad open to front, back and side

FEATURES

- e-Ribbon™ technology
- 8mm aluminium casing and baseplate
- Powder-coated black fine structure
- Touch Display
- Bluetooth / App control
- Remote Control
- 1-5 + eco flame levels
- Smart home connection
- Safety sensors
- No chimney required
- Sleep Timer
- Safety chamber
- Glass screen

TECHNICAL INFORMATION

The example illustrated below is a Montreal open to front LxHxD 1400x400x300mm and Flame tray size: 1200mm.

Capacity: 11,4 L

Fuel consumption: 0,5 L - 1,3L

Burning time: 9h - 23h

Heat output: 2,8 kW - 7,7 kW

Net weight: 71,4kg

Minimum room size: 153m³

Power supply: 220V - 240V - 50 Hz

Finish: Powder-coated aluminum or brushed stainless steel and optional hardened, optic-white glass

OPTIONAL

- Made to measure
- Extra glass screens
- Brushed Stainless Steel finish
- RAL colors
- TV temp. sensor



STANDARD FINISHES



OPTIONAL

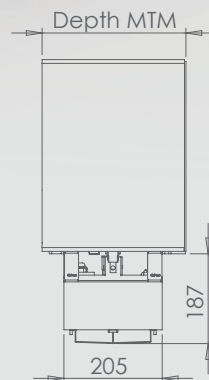
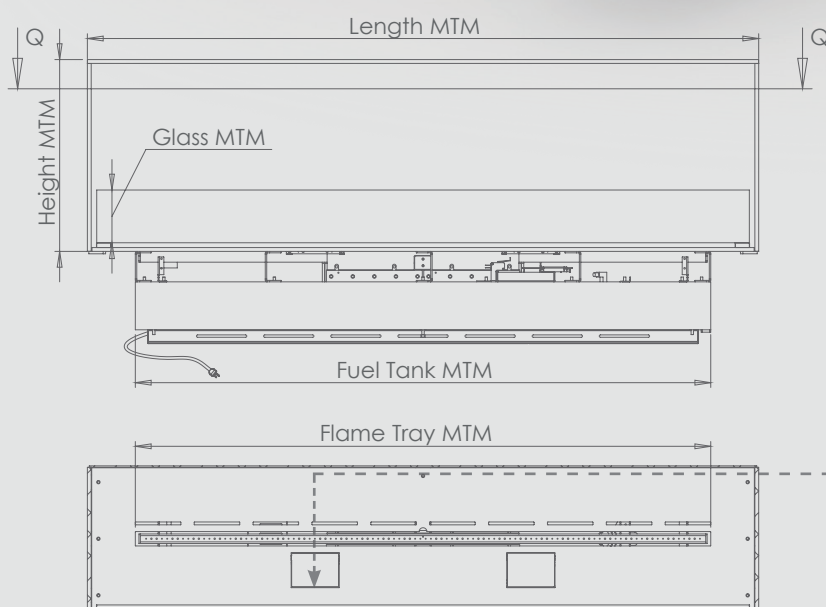
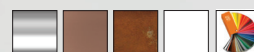

SECTION Q-Q

Touch Screen

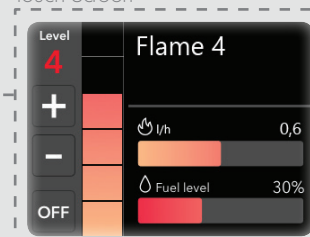

MONTREAL E-RIBBON™

Cut-out dimensions

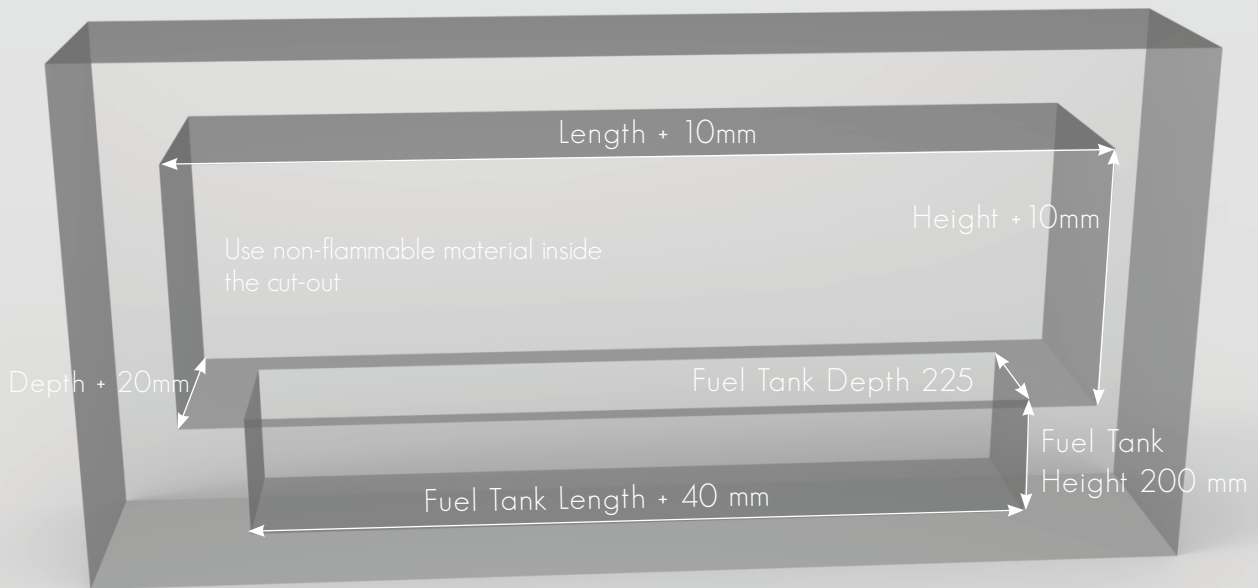

WALL CUT-OUT

Example: Montreal open to front LxHxD 1400x400x300mm and Flame Tray size: 1200mm
The wall cut out will be LxHxD 1410x410x320mm and the recess for the fuel tank will be LxDxH 1240x225x200. It is not centered. The distance from the front of the wall to the recess is specified in the drawing for the fireplace.

Heat Zone

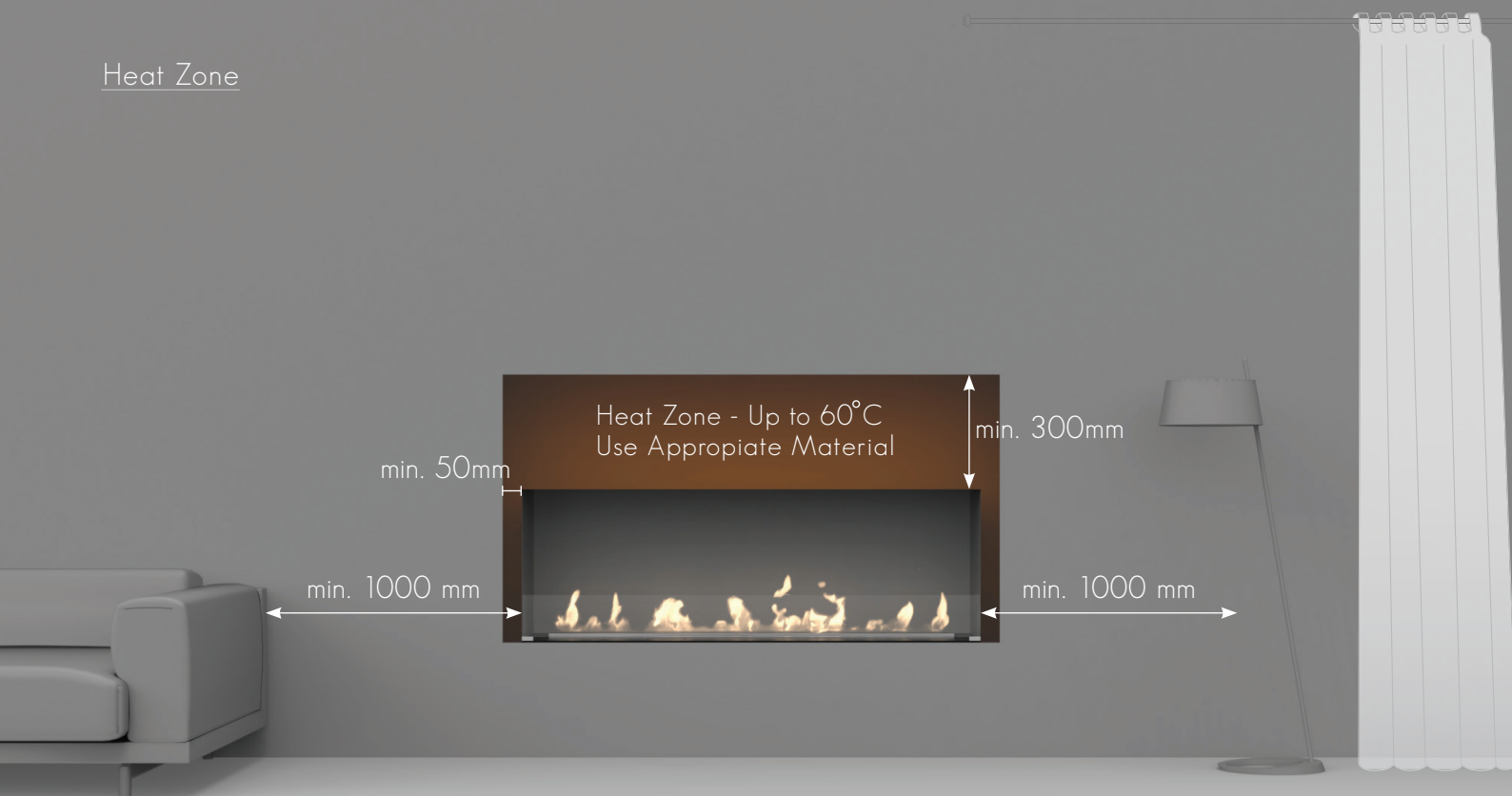

MONTREAL E-RIBBON™

www.decoflame.com

Montreal Installation

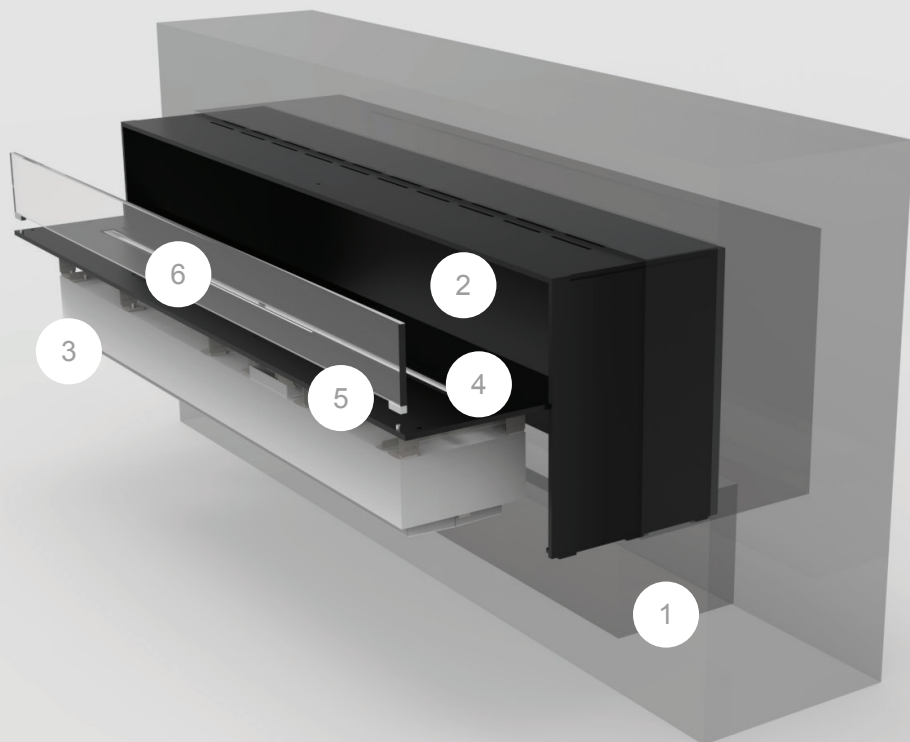

Step 1: Make sure that the dimensions of the cut-out correspond to the measurements indicated in the technical drawing received with your fireplace. Also be sure there is no draft inside the wall.

Step 2: Recess the fireplace casing into the wall cut-out according to the indications in the User's manual.

Step 3: Connect the burner to a source of electricity.

Step 4: Carefully lower the burner with baseplate in place. Attach with screws

Step 5: If the case, place the glass screen on the top plate by fitting the pin holders into the holes.

Step 6: Turn on the display. Fill in the right amount of bioethanol by verifying the level on the display.

Step 7: Start the fireplace by pressing the ON icon on the display.

DecoFlame Bluetooth Application Installation



App Store



Google play

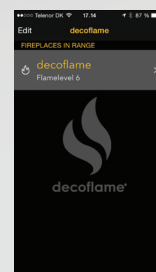
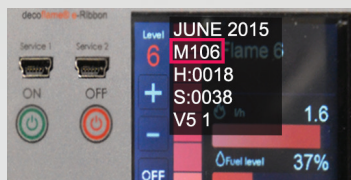

1. Download and install the DecoFlame App by scanning the QR code above corresponding to your smart device's operating system.

2. In order to pair your fireplace with your smart device, start the fireplace by pressing 'ON' button and insert the code highlighted above.

Note: The code will appear only for a few seconds. Make sure that you write it down or take a picture of it.

3. Once your device is paired, the fireplace should be visible on the app. You are now able to change the name of the fireplace.

Note: You are able to pair more than one fireplace like described in the step nr. 2 and give them different names.

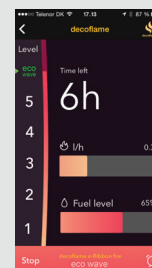
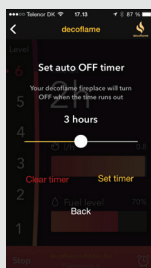

4. Once you have selected your fireplace, you can turn it on by pressing 'START'. If the fireplace has already been turned on using the display, you can now monitor the fuel level and the consumption.

5. For the 'Turn Off Timer' press the clock icon in the lower right corner. To adjust the remaining time, slide the dot to the left and right and select 'SET TIMER'. The remaining burning time can be changed by repeating the above mentioned steps. To cancel the timer select 'CLEAR TIMER'.

6. For adjusting the flame intensity, select the desired level on the left side of the screen. (1-lowest, 5-highest + eco wave). Should there not be enough fuel for the selected burning time - the fireplace will shut down automatically. Select 'STOP' to turn off the fireplace.

MONTREAL E-RIBBON™

www.decoflame.com

DecoFlame strongly recommends installing one or more glass shields in order to protect the flame from draught, while keeping it vivid. Please see below the situations where the glass is optional and where it is mandatory.

Mandatory glass

Open to front



2D Cad Montreal open to front

Optional glass

Open to front and back



2D Cad open to front and back

Open to front and side

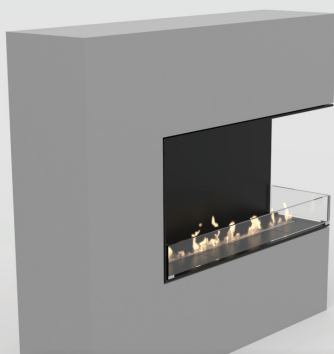

2D Cad open to front and right side

Open to front, back and side

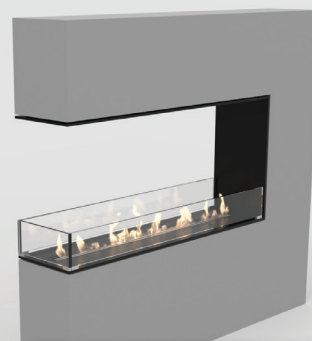

2D Cad open to front, back and side

Open to front and both sides



2D Cad open to front and both sides

The wall cut-out for the different types of Montreal can be found in the drawings for your specific fireplace or in the autocad drawing available for download on this page.

MONTREAL E-RIBBON™

www.decoflame.com

It is imperative to follow the indications in the User's manual concerning the installation of decorative or electronic items above the fireplace.



MONTREAL E-RIBBON™

www.decoflame.com



Take a video tour in our showroom

Take a virtual tour in our showroom

